

**CHAPTER 15
ILLUSTRATED DICTIONARY OF TOOLS**

The illustrated dictionary of tools is intended to provide a clear understanding of what tools are required to maintain the press. Special tools for

the press are listed and illustrated in the special tools section of the IPL (see Section 11.3).

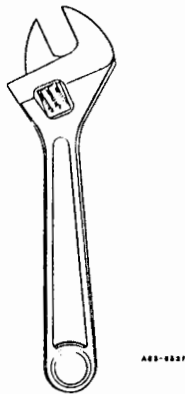

Adjustable-End Wrench

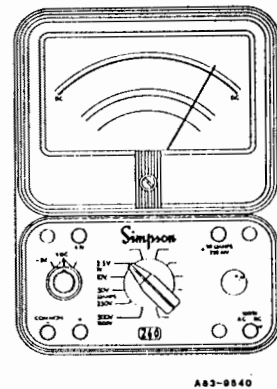

Analog Volt/Ohm Meter

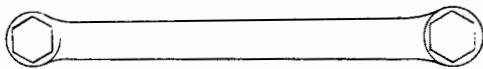

Closed-End Wrench

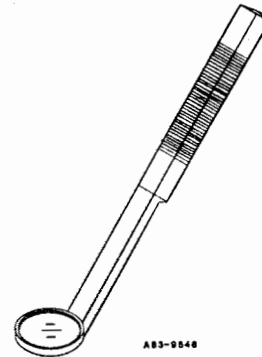

Dental-Type Inspection Mirror

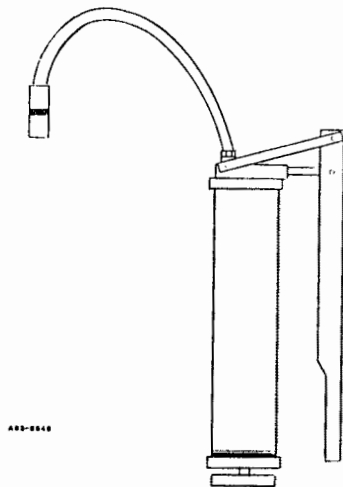

Grease Gun

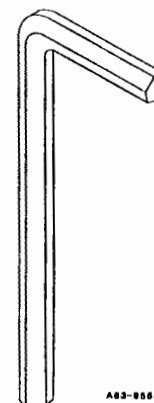

Hex Wrench

ILLUSTRATED DICTIONARY OF TOOLS



Machinist's Tool

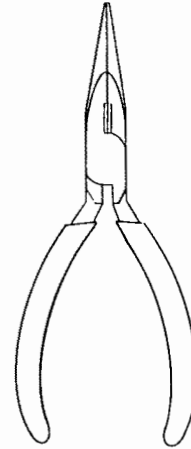

Needle-Nose Pliers



Open-End Wrench

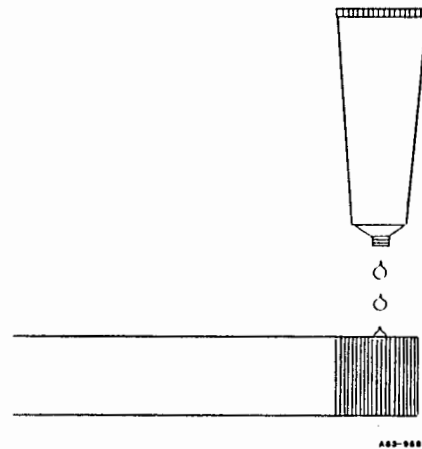

Pipe Joint Compound

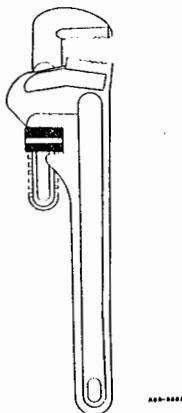

Pipe Wrench



Propane Torch

ILLUSTRATED DICTIONARY OF TOOLS



Regular Pliers



Rubber Hammer

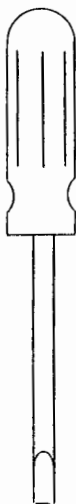

**Flat-Tip
Screwdriver**



**Phillips
Screwdriver**



Side Cutters

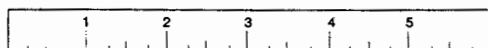

Scale, 6" (150mm)

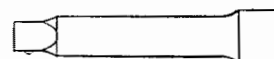
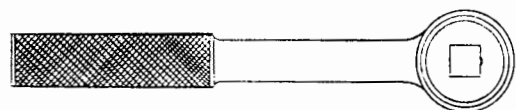

Socket, Handle, & Extension

ILLUSTRATED DICTIONARY OF TOOLS

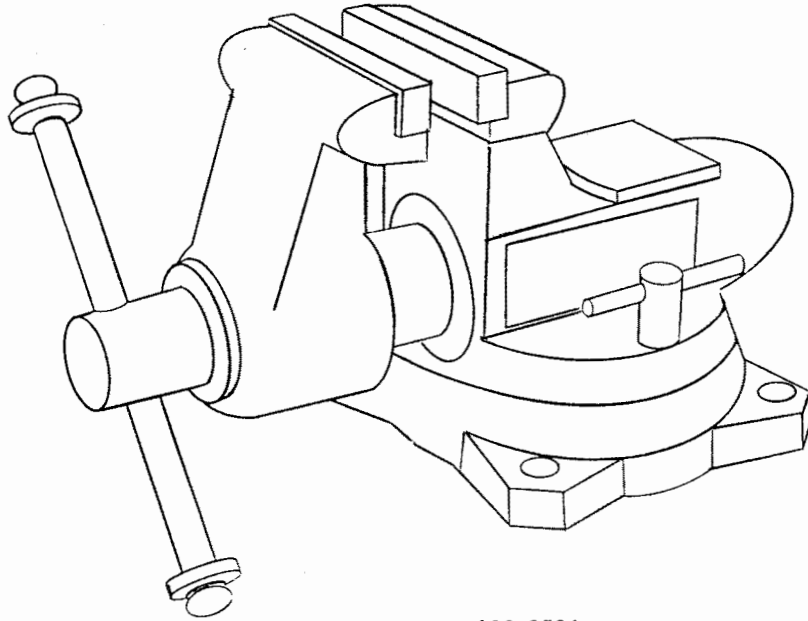

A83-9581

Vise